



# Helsinki Oak

**9**  
PANELS

1380 x 193 x 7 mm = **2,397 m<sup>2</sup>**  
14 kg approx.

## AC 3 · 31

EN ISO 10874



Home

**GUARANTEE**  
**10 YEARS**

acc. to SWISS KRONO TEX conditions

EN ISO 10874



Commercial use

**GUARANTEE**  
**2 YEARS**

acc. to SWISS KRONO TEX conditions

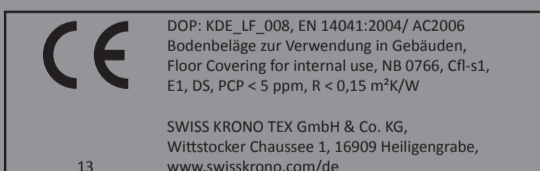
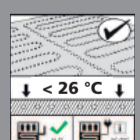
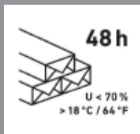

SWISS KRONO TEX GmbH & Co. KG,  
Wittstocker Chaussee 1, 16909 Heiligengrabe,  
[www.swisskrono.com/de](http://www.swisskrono.com/de)

13



Made in Germany

2059.1

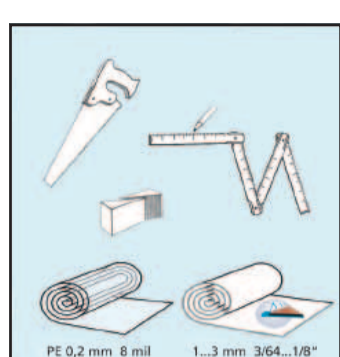
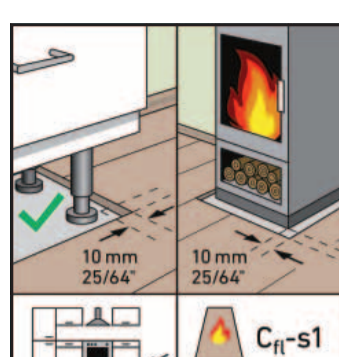
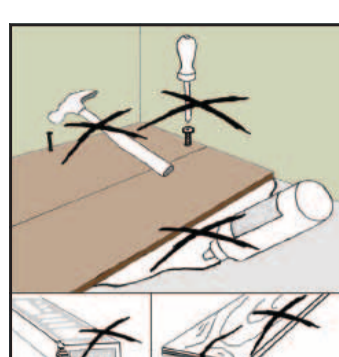
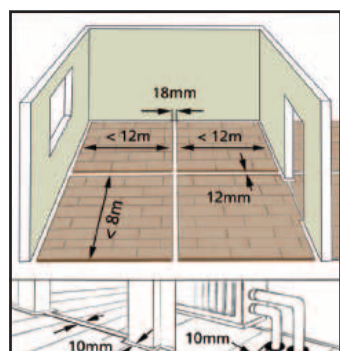
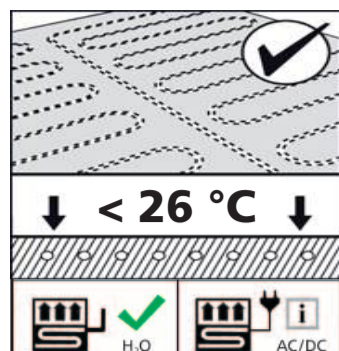

## INSTALLATION

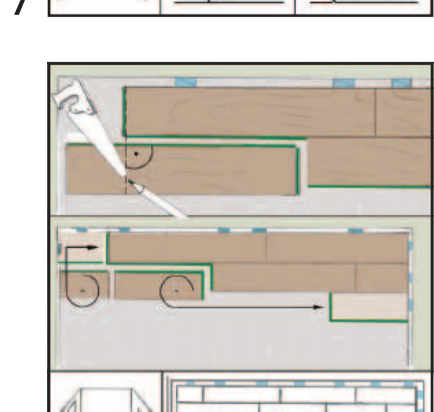
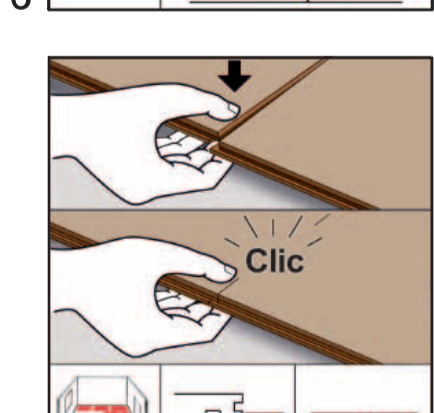
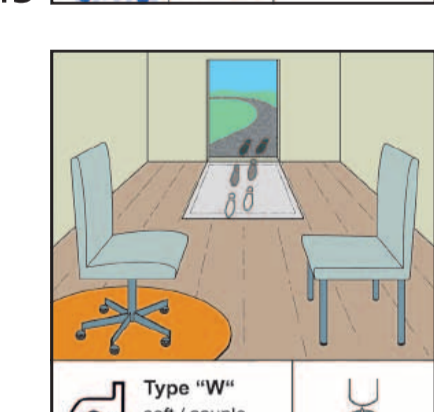
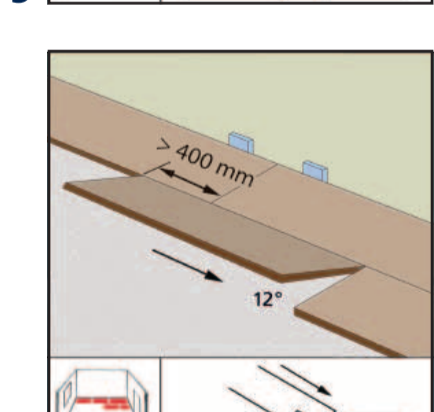
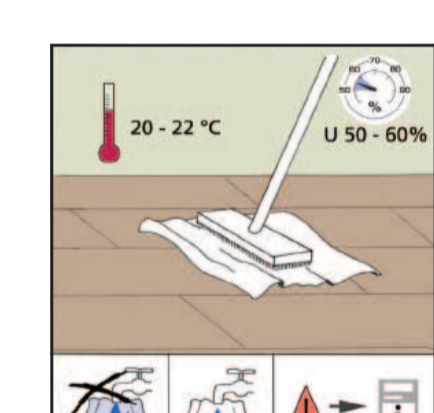
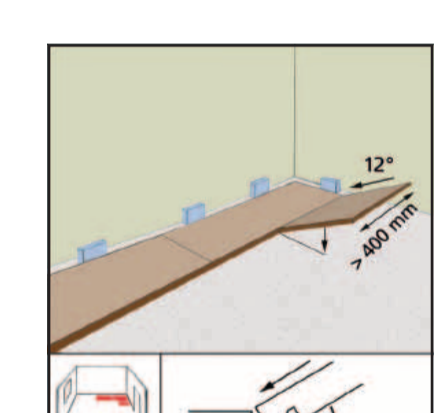
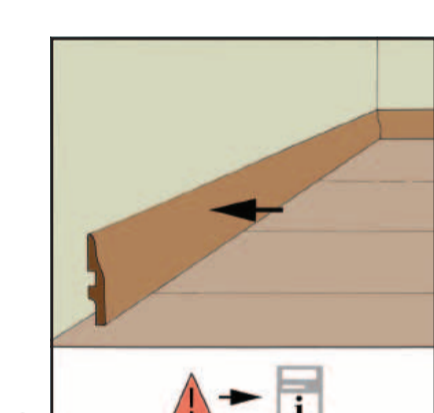
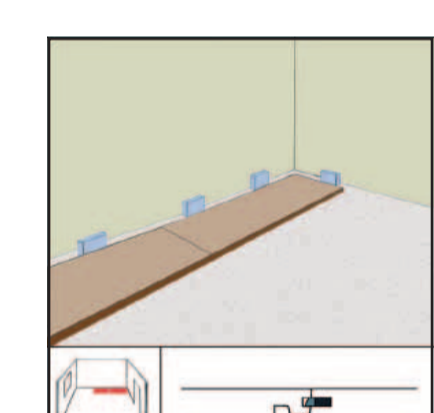
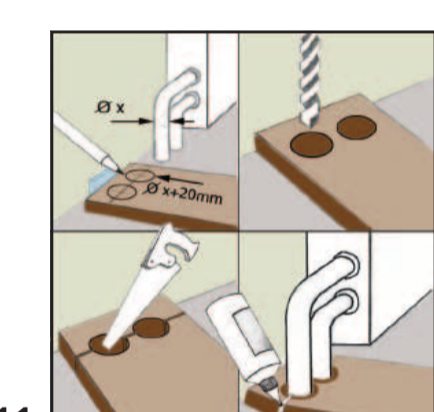
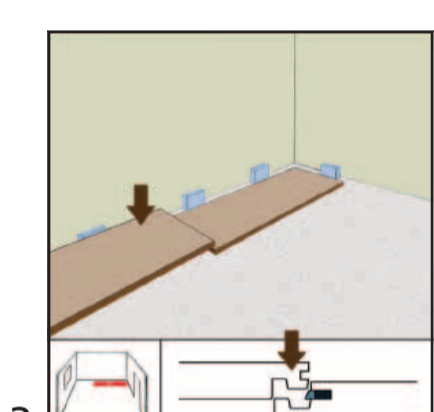
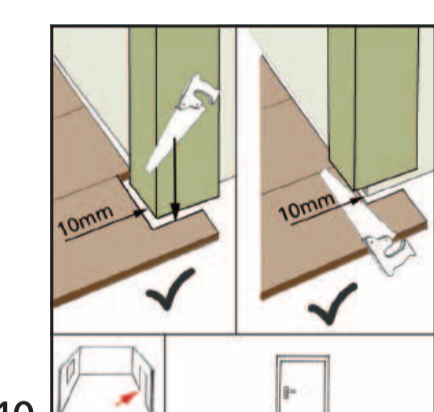
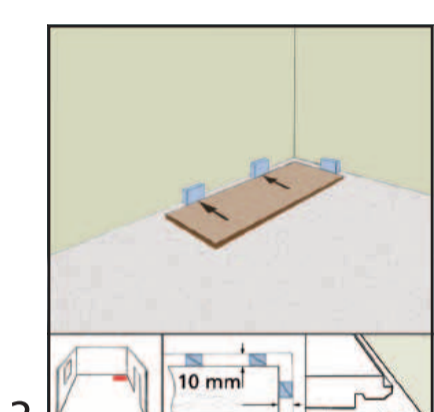
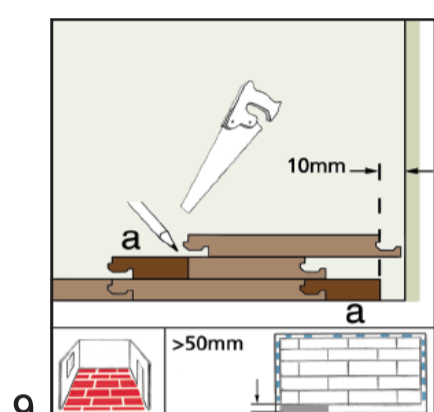
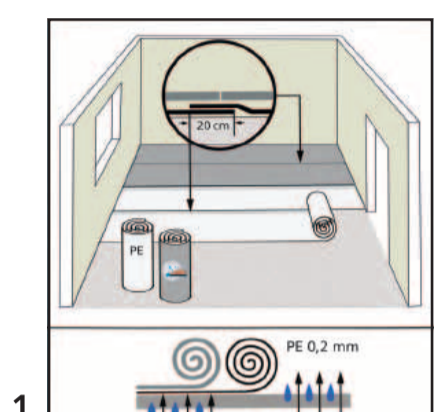

## REMOVAL

